

Sistema Tende a Pannelli



Le tende a pannello sono ideali per ambienti con uno stile moderno e minimalista, particolarmente indicate per superfici grandi come ampie vetrate o finestre.

Le semplicità dei pannelli può essere abbinata a molteplici tessuti, ognuno dei quali potrà dare una sfaccettatura e uno stile differente all'intero ambiente

SISTEMA PER TENDE A PANNELLO

UTILIZZO



- Sistema per tende a pannello
- Azionamento: con corde, a strappo o con asta
- Indicato per tendaggi di larghezza massima cm. 600
- Apertura tende: centrale, laterale e asimmetrica
- Il sistema di scorrimento delle corde è situato in canali indipendenti e paralleli ai teli
- Il sistema è indicato per installazioni a soffitto o a parete (con supporti Combi o decorativi)
- Lo scorrimento è garantito da rotelle calibrate autolubrificanti

CARATTERISTICHE TECNICHE

- Profilo in lega d'alluminio estrusa 6060 T5 UNI 9006/1
- Dimensioni mm: 2 vie 16,5 x 41 / 3 vie 16,5 x 61 / 4 vie 16,5 x 81 / 5 vie 16,5 x 101
- Canale di scorrimento mm. 6
- Colori disponibili:
 - verniciatura a polvere a base di resine poliesteri omologata a marchio QUALICOAT BIANCO RAL 9010
 - lucidatura effetto Inox con ossidazione neutra di protezione
- Tappo terminale in acetalica antiurto con inserto guida corde
- Accessori in acetalica autolubrificante
- Portatelo in:
 - lega d'alluminio estrusa 6060 T5 UNI 9006/1 con Velcro® adesivo (bloccato su tutta la lunghezza)
- Pesotenda in lega d'alluminio estrusa 6060 T5 UNI 9006/1
 - piattina 40x4
 - GOCCIA decorativo 44x20

COLORI

STANDARD

	101 BIANCO
	106 INOX

SOLUZIONI

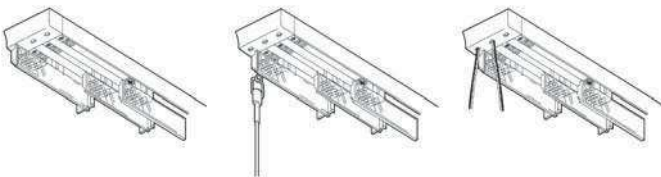

Optional doppia apertura

Solo 5 vie



PORTATELO E PESOTENDA

Portatelo in lega d'alluminio

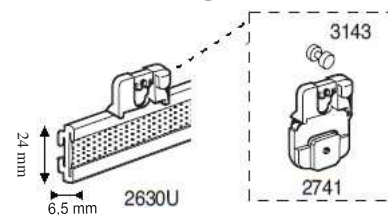

Pesotenda

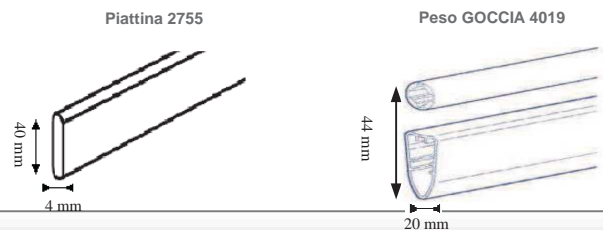

MISURE PROFILI

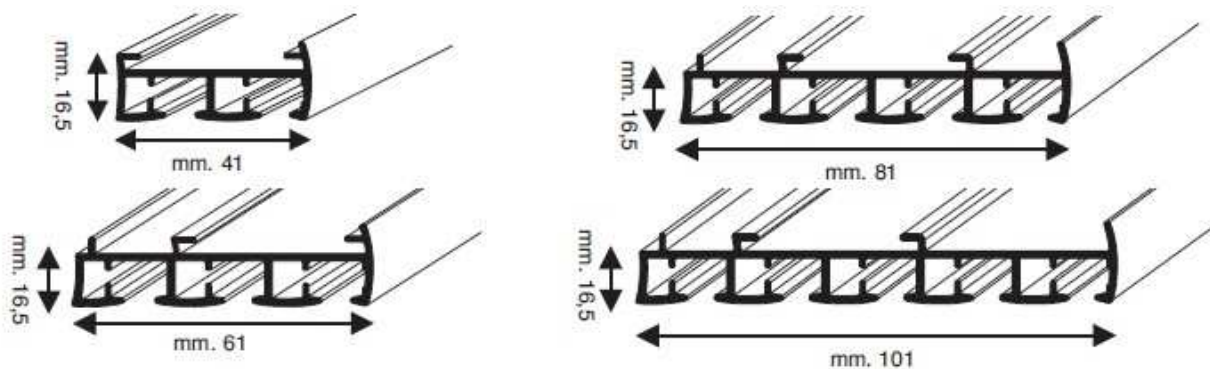

3 vie + 3 vie



3 vie + 4 vie



4 vie + 4 vie

SISTEMA PER TENDE A PANNELLO

INSTALLAZIONI

A soffitto

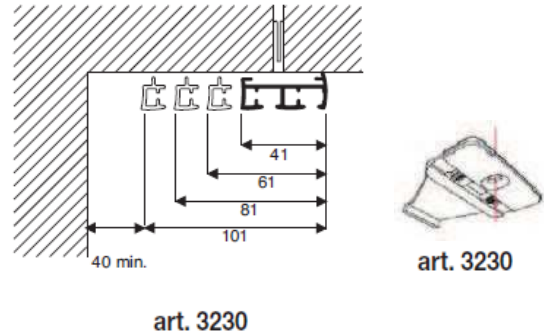
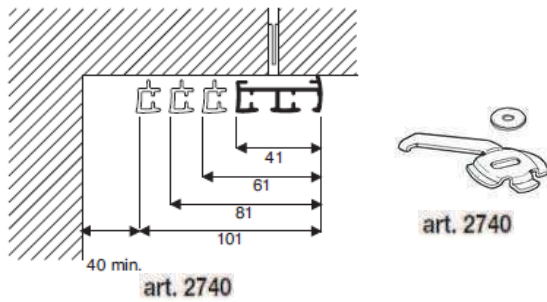

A parete

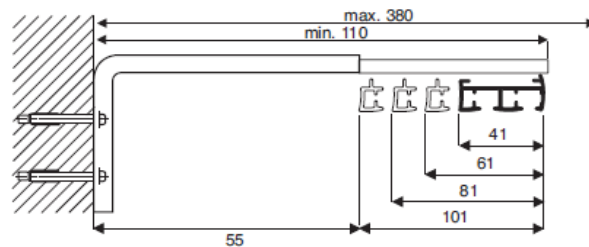
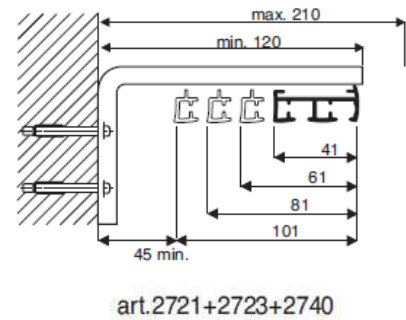
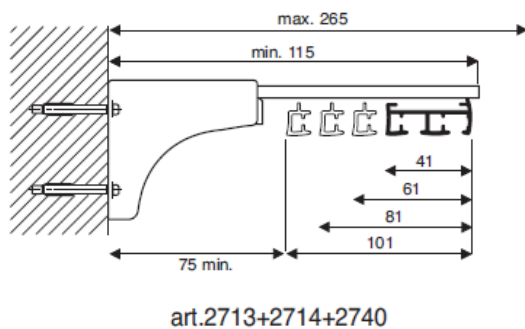

art.2721+2714+2740

SISTEMA PER TENDE A PANNELLO

INSTALLAZIONI DECORATIVE

A soffitto con supporto Art. 3216

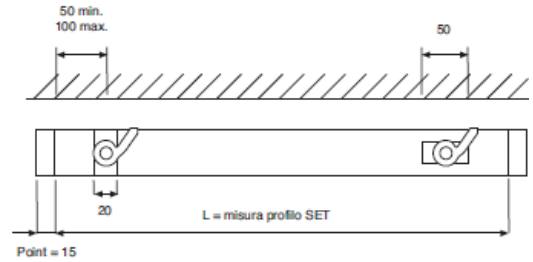
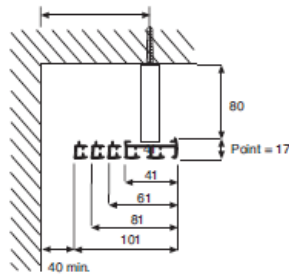

A parete con mensola ARC Art. 3230/S

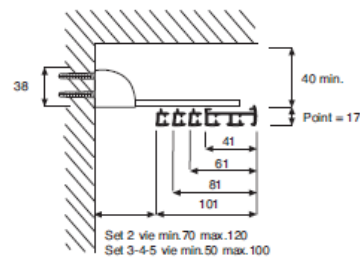
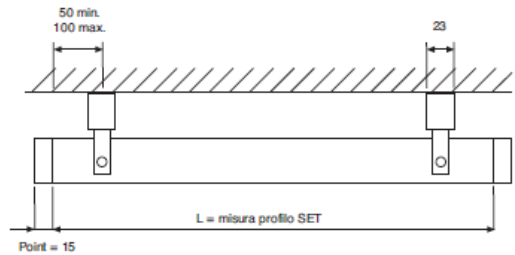
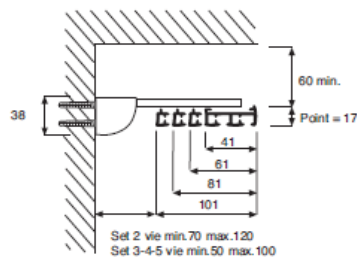

A parete con mensola Art. 3218

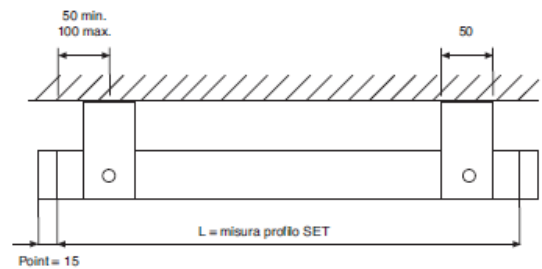
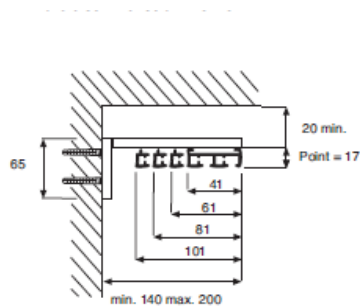

SISTEMA PER TENDE A PANNELLO

ESPLOSO CON SUPPORTI COMBI

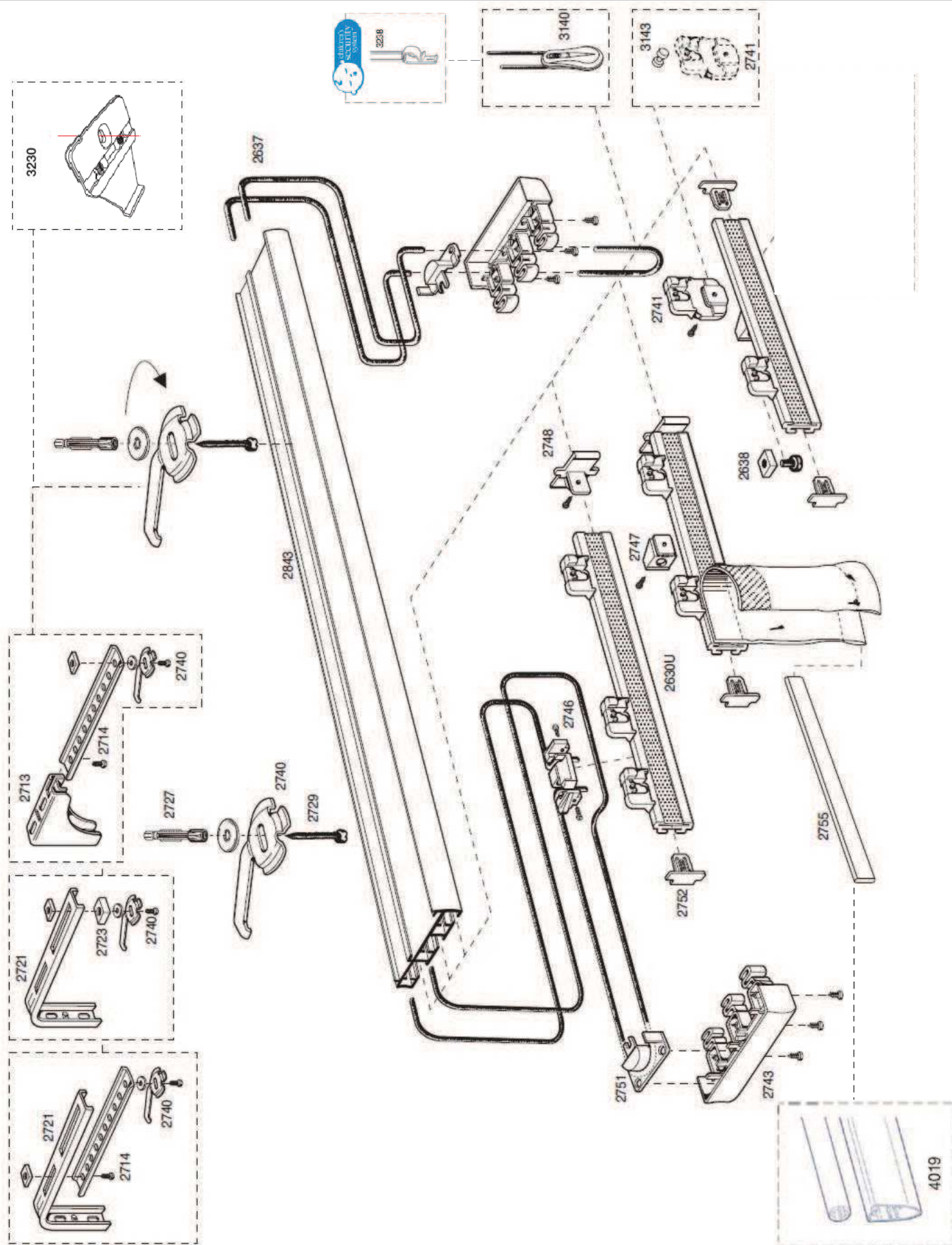

SISTEMA PER TENDE A PANNELLO

ESPLOSO CON SUPPORTI DECORATIVI

